

SALONA
XXXIII ▶ 33
XXXV ▶ 35









HERITAGE

The remains of the ancient City of Salona, the most important city in the ancient world, are located six kilometres north of Split. Salona's favourable geographical position in the middle of the Eastern Adriatic Coast and its location within the well-protected Kastela Bay, along the delta of the river Salon (present Jadro) as well as good road connections, presented a precondition for fast and smooth development of this incredibly inspiring city, the metropolis of the Roman Province of Dalmatia.

Salona was initially a coastal stronghold and a port of the Illyrian Delmati. Furthermore, this port located in the eastern wing of the protected bay was a great impetus for the development of the city. The development was caused primarily by trade activities, and then, especially in the late centuries, by

the change in people, worldviews, religious teachings, construction, shipbuilding, and other skills.

Today, Salona, materially speaking, is a pile of scattered and disposed remnants giving us just an idea of its former size, strength, extraordinary power and culture. Thus, a broken part of the letter, more precisely the serif of the initial letter "S" from the "SALONA" inscription, symbolizes today's Salona and its remnants. But even more, it symbolizes the former mighty Salona. All of this is exactly what the serif through monumental capital represents. When the broken piece of the letter breaks off as shown in our logo, it resembles a sailboat and refers to the ancient shipbuilding tradition that the people of this area have been dealing with since the ancient times.



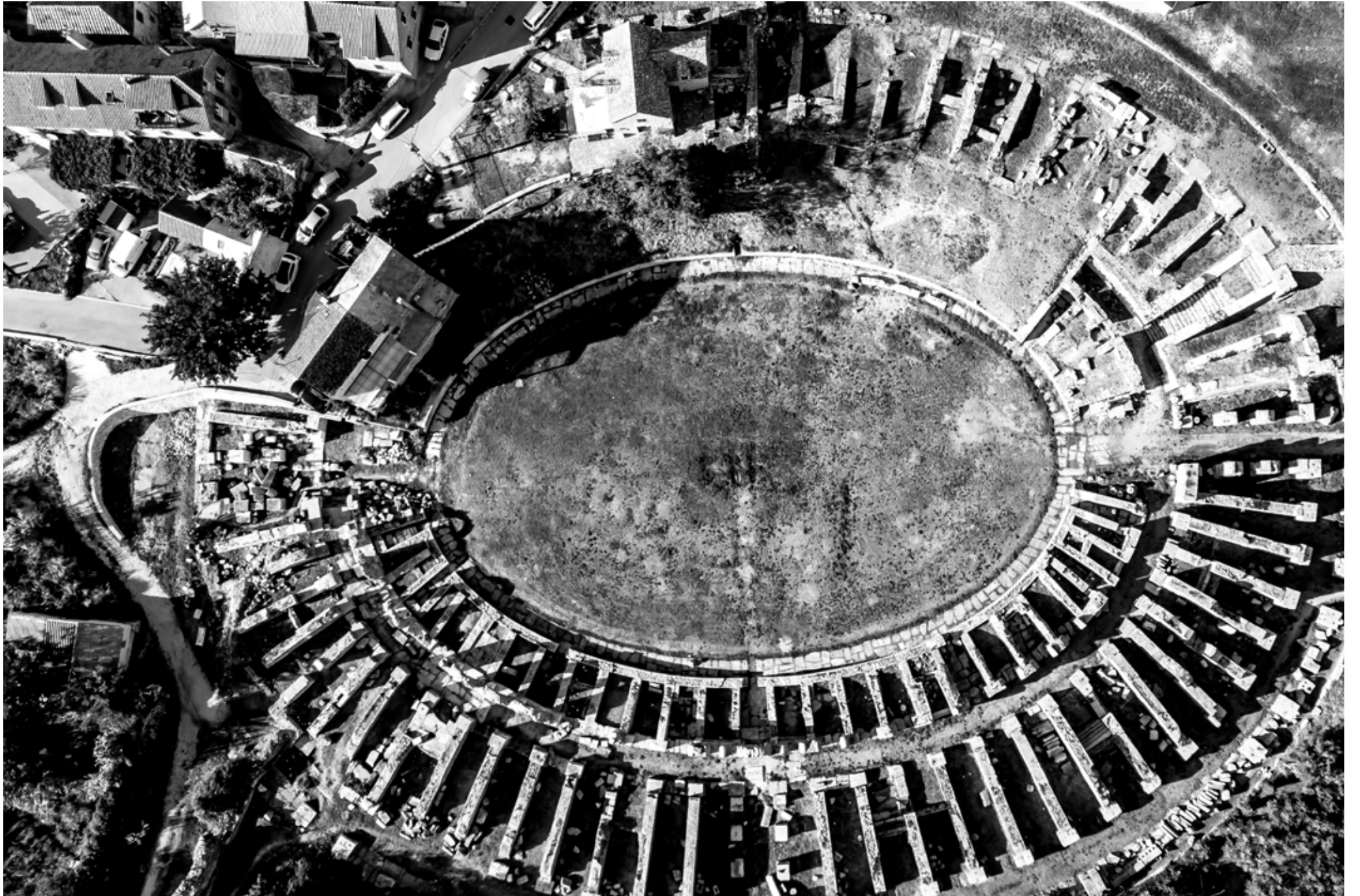



SUPREME SAILING SATISFACTION

The Salona combines the best in technology, design, quality and comfort. It is simply fast and seaworthy and at the same time comfortable inside, with the right cockpit heights, and outside, with a wide cockpit deck featuring comfortable benches and easy access to the mainsail winches from the helmsman position. The underwater profile is composed of a long aluminum stock rudder that guarantees stability and control, as well as a standard modern keel design of two meters.

More than a thousand years of shipbuilding experience, knowledge and passion, passed from generation to generation, is incorporated in Salona brand. Strong and light structure, which is a consequence of the advanced building techniques, such as vacuum infusion of the hulls and decks, results in surpassing sailing performance.

The Salona yacht can easily be sailed shorthanded, but crew comfort and safety are secured by ergonomically designed layouts that offer functional and elegant seats for pleasant family cruising. Our after-sales network is active on five continents, meaning that our Salona owner will never feel alone.









SALONA QUALITY THAT MAKES THE DIFFERENCE



From the very beginning, at Salona Shipyard, we are dedicated to getting every detail incorporated while aiming for the performance perfection and enjoyment.

The first-class components and modern building materials, make our yachts an example of uncompromised construction quality. Additionally, our yachts provide enjoyment in sailing in a wide range of conditions.

Apart from the mentioned, Salona, as all our models, has been reinforced with stainless steel interior frame structure which supports the keel, mast, and shrouds, giving the yacht a solid, but light structure. The production process has been optimized for quality control, enabling each vessel inspection at every production phase. After the boat leaves the production site, our team of experts is at service for all questions from Salona owners.

The superior yacht equipment is made by world-leading companies, perfectly matching the Salona style. But the technology itself is

not what makes the yacht a great one. It is the team of experienced employees at our shipyard that create the perfect dream yacht!

The Salona comes with a comprehensive range of options to suit the taste of every individual's sailing experience!



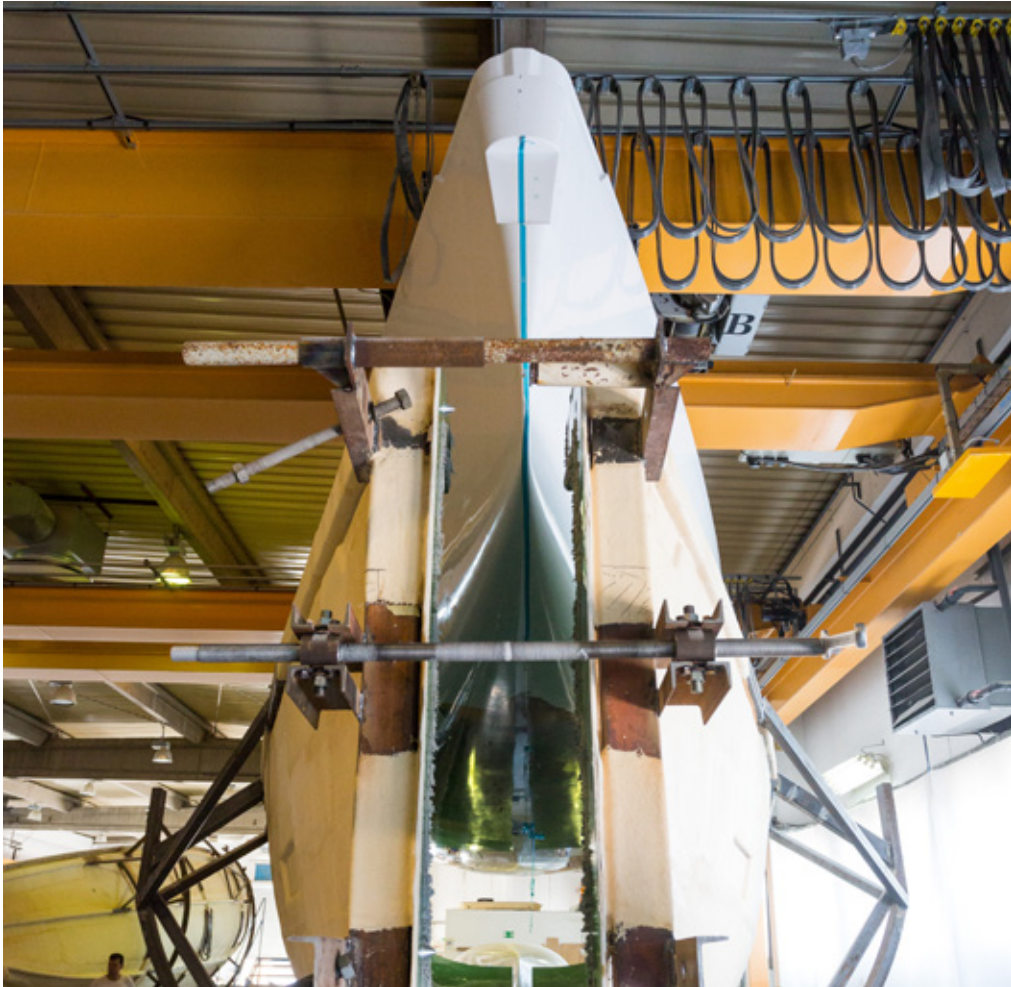

SALONA EXCELLENCE

SALONA STRUCTURES

The hull and deck laminates of the Salona are constructed using the latest vacuum infusion technology combined with tri-axial oriented fibreglass fabric. The innovative grid construction provides skippers with the confidence to take the Salona across any ocean condition without hesitation.



VACUUM INFUSED CONSTRUCTION

- the hull is constructed using vacuum infusion technology, obtaining an extremely stiff and lightweight hull.



STAINLESS STEEL STRUCTURAL GRID

The Hallmark feature of every Salona yacht is the stainless steel grid that connects the Keel, with the mast and the shrouds, sharing the load of the rig evenly throughout the hull. This grid, combined with the vacuum infused hull makes the Salona one of the stiffest production boats in the market with an amazing upwind performance.

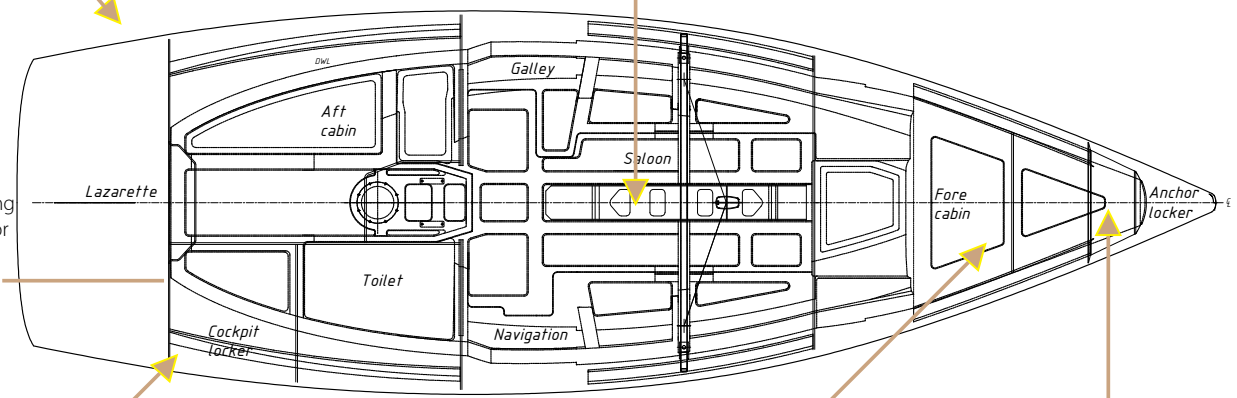

WATERTIGHT BULKHEADS AFT
Watertight bulkheads separate the steering area from the interior accommodations for safety and reassurance in the event of a rudder loss.

BULKHEADS
The Salona has the option to have the bulkheads in carbon to add strength, stiffness and weight savings.

WATERTIGHT BULKHEADS
Watertight bulkheads separate the anchor compartment and the interior accommodation for safety and reassurance in the event of a collision.

MADE TO BE DIFFERENT

The vacuum infused hull and deck make sure that the ratio between fibre and resin is perfect and guarantees optimal strength and weight. Vacuum infusion makes boats lighter and stiffer.

The underwater part of Salona yacht is covered with a transparent gel coat, which ensures the highest standard of quality control.

At the heart of every Salona yacht, there is a steel frame that securely distributes the load from the keel, shrouds, and mast evenly throughout the hull, resulting in maximum

stiffness and excellent upwind performance. This process ensures extra safety and outstanding quality.



LUXURIOUS OUTDOOR



Every detail concerning the Salona was carefully chosen to offer the perfect result in safety, style, and ergonomics while simultaneously providing the attractive experience of freedom and life on a perfect dream yacht.

Salona 33 and 35 models are a result of our experience gained throughout creation and daily use of all our models, from 33 to 46 ft. Her modern and clean deck lines are the continuation of the new distinctive style of Salona.





INDOOR ELEGANCE



Joining lavish comfort with superb functionality, the Salona interiors are created with passion and an in-depth understanding of our customers' needs.

The Salona yacht includes a beautiful saloon with a large L shape sofa and sofa on the starboard side, enabling the entire crew to gather in one spot. Living is made easy with foldable tables, chart desk and saloon table with bottle storage inside.

The L shaped galley on the port side provides ample storage and work surfaces with strategically placed grab rails, providing the perfect environment for preparing the perfect dish and keeping the crew safe even in open waters.

Both two and three-cabin versions are available with king-size beds and full standing height, not forgetting good size wardrobes and storage facilities suitable for a memorable and comfortable sailing journey with family or friends.



The Salona comes with a comprehensive range of options to ensure that we can perfectly tailor the yacht to each individual's sailing experience.

In this brochure, we will showcase the standard features and basic level of customization.

The elegant and comfortable cabins with large beds provide ample accommodation and plenty of space for the outstanding gatherings of friends, family, or crew. It also features comfortable bathroom, with an option for separate shower room for the superb convenience.

The Salona 33 will satisfy a wide range of customer demands, from safe family cruising to high level IRC or ORC racing. The S33 combines a proven and optimized hull shape, two mast options and version of cruising and performance keels with various draft options. Salona has created modern and inviting interior space by using a mix of GRP and different wood interior options, while reducing performance weight.

LAYOUT OPTIONS 33

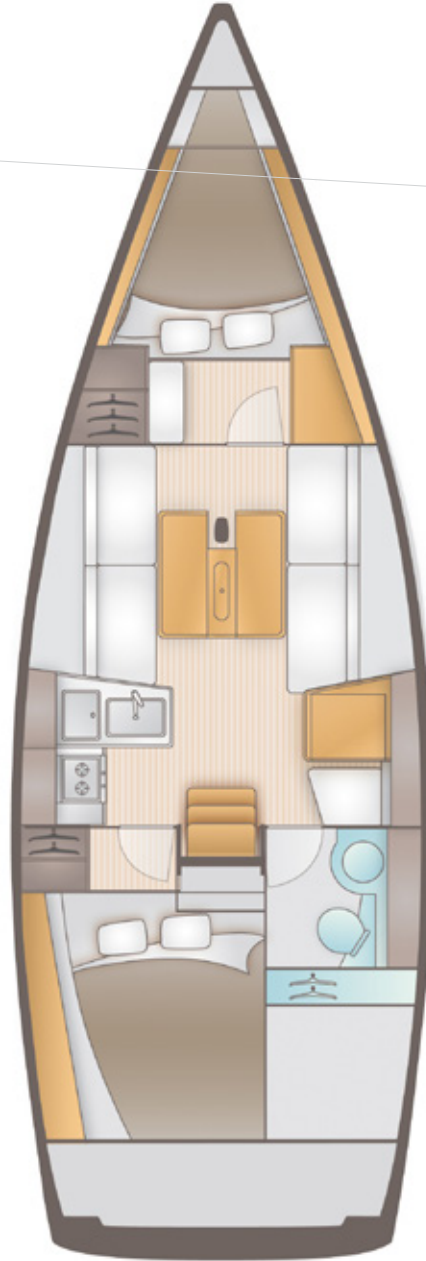

LAYOUT OPTIONS 33



LAYOUT OPTIONS 35

SALONA 35 has two spacious lockers with additional dedicated locker for two gas bottles, two steering wheels with carbon pedestals (optional) and top quality sailing gear which makes single handed sailing easier.

Construction, technology and innovation have always been the strong points of the Salona yard and on S35 we have combined our experience with the use of hi tech materials and smart design features. As on all our models the big stainless steel frame takes the loads from the keel and shrouds and spreads them securely to a wide area of the hull. On the Salona 35 we have gone one step further in achieving maximum stiffness and durability of the boat by adding the layers of carbon fibre on carefully analyzed areas of hull inner liner to obtain equilibrium of stainless steel structure and inner liner attached to it, making her one of the best value 35ft performance cruisers on the market. Filled with daylight coming through hull windows with hatches and numerous smart design details, saloon is the perfect place to relax and enjoy the comfort of our yacht. Standard interior is 2 cabin version with spacious head and large navigation table, functional galley and folding bunk beds in the saloon (optional).

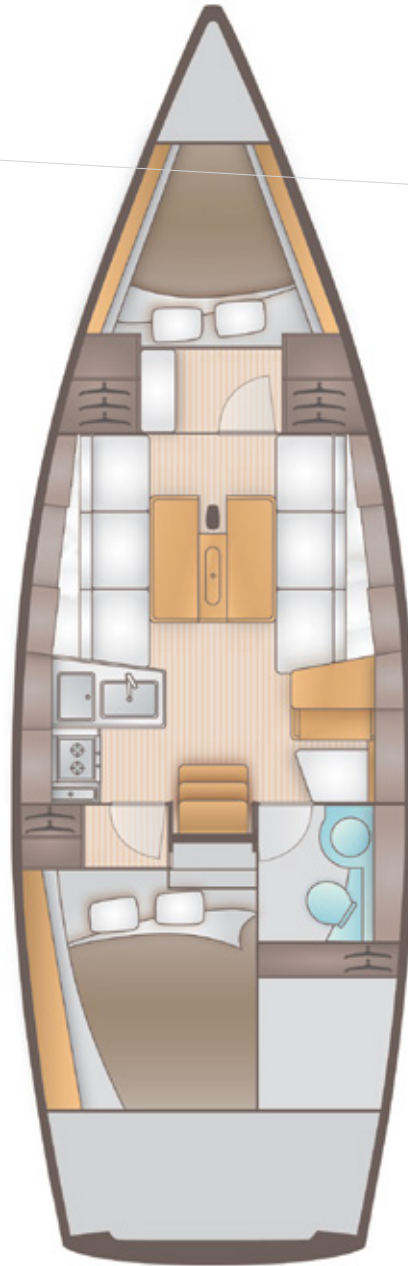

UPHOLSTERY AND WOODEN SAMPLES

SALONA can be additionally customised with a wide range of colors and fabric choices:

Gelcoat colors

Gelcoat

Blue



Grey



Red



White Standard



Stripes

Stripes

Black - Standard



Blue



Gray



Red



Blue hull



Gray hull



Red hull



Furniture wood

Teak



Oak



Bleached Oak



Floor board

Mahagony & Holly



Teak & Holly



Walnut

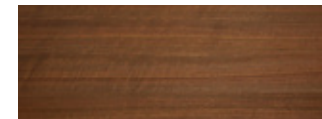

Ash



UPHOLSTERY AND WOODEN SAMPLES

Upholstery

JADE- Standard

Jade_9370



Jade_9120

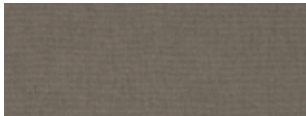

Jade_9402



Jade_9605



Jade_9410

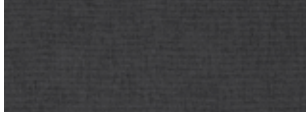

TIAGO- Optional

Tiago_9130



Tiago_5453



Tiago_6110



Tiago_3718



Tiago_5454



CEDROS- Optional

Cedros_9440_pl



Cedros_9603_pl

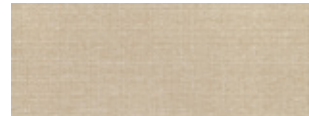

Cedros_9160_pl



Cedros_9905_pl



INVICTUS _ Artfical leather-Optional

Invictus_8104_pl

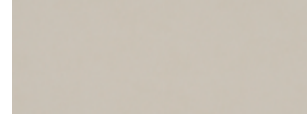

Invictus_3102_pl

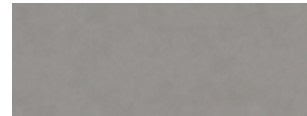

Invictus_5483_pl



Invictus_5474_pl



Invictus_9000_pl

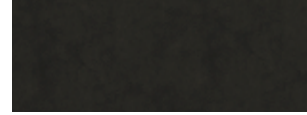

Exterior fabrics

Sunbrella 5030 Oyster



Sunbrella 5035 Silver



Sunbrella 5026 Dune

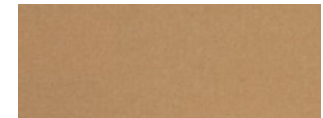

Sunbrella 5088 Charcoal Pique



Sunbrella 5029 Jockey Red



SPECIFICATIONS

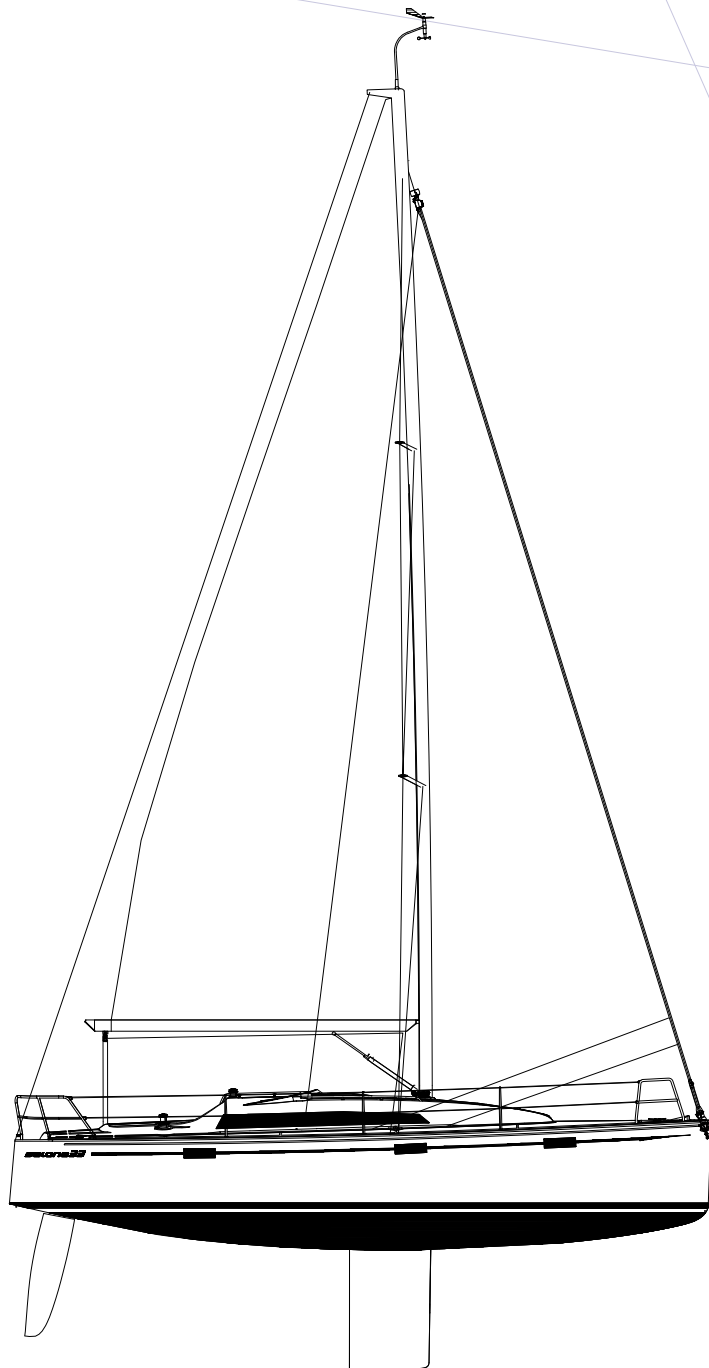

TECHNICAL DATA

Length Overall (LOA)	9,99 m / 33' ft
Length Waterline (LWL)	9,04 m / 29,6' ft
Beam Max	3,35 m / 10' ft
Draft	1,5 / 1,75 / 2,00 / 2,15 m 5' / 5,7' / 6,5' / 7' ft
Displacement Empty	4.950 kg / 10.912 lbs
Ballast	1.100 - 1.480 kg / 2.425 - 3.262 lbs
I	13,03 m / 42,7' ft
J	3,79 m / 12,4' ft
P	12,50 m / 41' ft
E	4,38 m / 14,37' ft
Mainsail full batten	32,00 m ² / 344 ft ²
Genoa furling	37,50 m ² / 403 ft ²
Sails area total	69,50 m ² / 747 ft ²
Fresh water tank	100 L / 26,4 gal
Black water tank	42 L / 11 gal
Fuel tank	90 L / 23,7 gal
Engine Yanmar	15,3 kW (21HP)
Design Category	A (Ocean)
Certification	DNV – GL (DIRECTIVE 94/25/EC)
Design	J&J / Salona design



SPECIFICATIONS

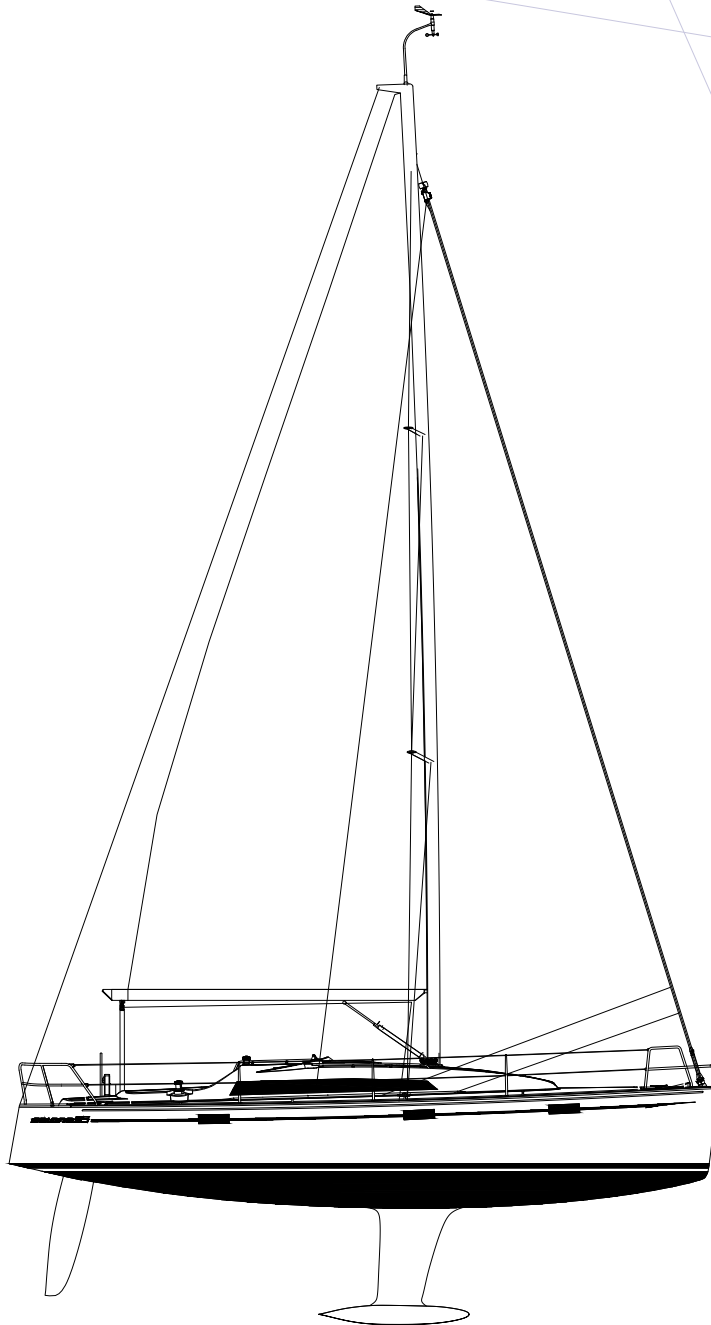

TECHNICAL DATA

Length Overall (LOA)	10,40 m / 34' ft
Length Waterline (LWL)	9,16 m / 30' ft
Beam Max	3,36 m / 11' ft
Draft	1,5 / 1,75 / 2,15 m 5' / 5,7' / 6,5' / 7' ft
Displacement Empty	5.300 kg / 11.684 lbs
Ballast	1.200 - 1.500 kg / 2.645 – 3.306 lbs
I	13,03 m / 42,7' ft
J	3,84 m / 12,5' ft
P	12,50 m / 41' ft
E	4,38 m / 14,3' ft
Mainsail full batten	32,00 m ² / 344 ft ²
Genoa furling	37,50 m ² / 403 ft ²
Sails area total	69,50 m ² / 747 ft ²
Fresh water tank	180 L / 47,5 gal
Black water tank	42 L / 11 gal
Fuel tank	90 L / 23,7 gal
Engine Yanmar	15,3 kW (21HP)
Design Category	A (Ocean)
Certification	DNV – GL (DIRECTIVE 94/25/EC)
Design	J&J/Salona design



ENVIRONMENTAL LUXURY YACHT

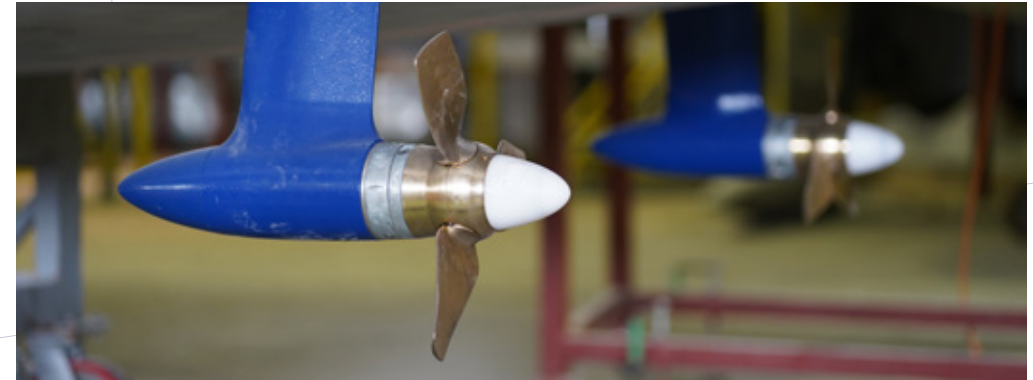
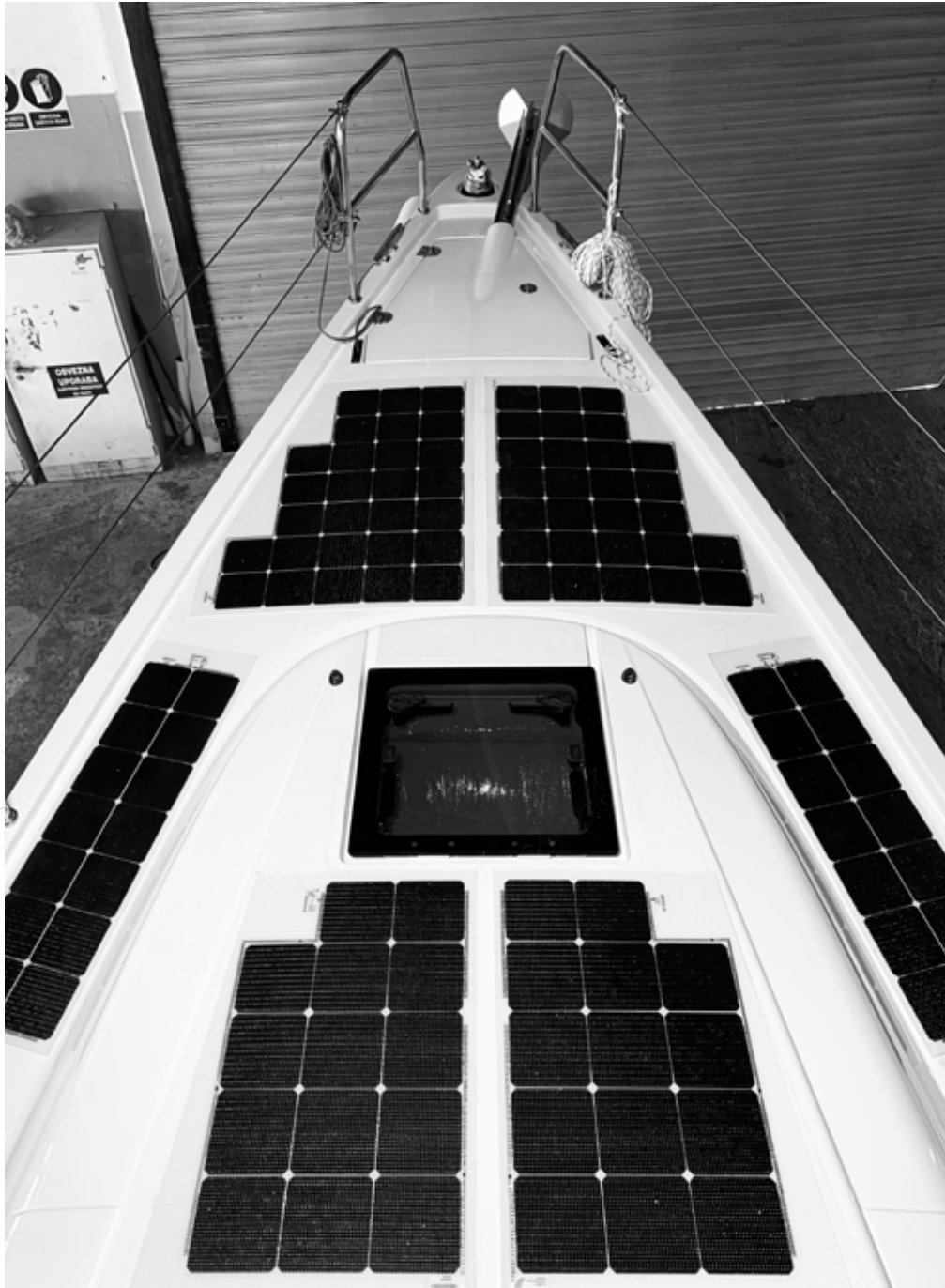

Salona is dedicated to supporting the electric-powered community on water!

We are actively developing, supporting, and promoting electric propulsion, which makes boating even better. We believe that the benefits of the electric propulsion are plentiful, such as:

- low maintenance
- improved safety
- no pollution
- silent operation
- reduced boat operation costs
- greater efficiency
- and our team will work passionately in the future to support yachting to become more sustainable and green.



WELCOME TO SALONA SHIPYARD IN CROATIA

Salona Yachts have been built in Croatia since 2001.

Croatia, as a country with a great reputation in boat building, is recognized as one of the most skilled boat building countries in Europe.

Having years of experience, Salona received several awards for the best yachts. One of the most notable awards that Salona won is the award for the European Boat of the Year and honour for a Boat of the Year in the US. We have aimed for the top quality, design, and winning performance while offering the supreme sailing delight to beginners or experienced sailors.

The best way to understand Salona is to try out our boats in their natural surrounding – on the sea. Therefore, we invite you to contact us and discover the World of Salona Yachts in Croatia at any time of your convenience.





SUPREME
SAILING
SATISFACTION



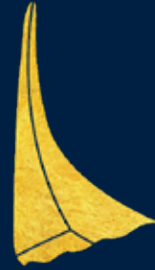

SALONA
Y A C H T S

salonayachts.com